

MB699V5P-B

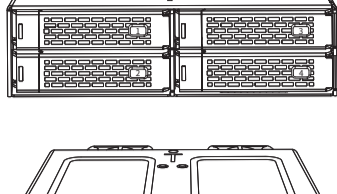

PCIe 5.0
SFF-9402 Rev 1.1 引脚定义



MB699VP-B



PCIe 4.0
传统引脚定义

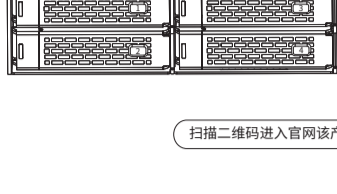

MB699VP-B V3



PCIe 4.0
SFF-9402 Rev 1.1 引脚定义

扫描二维码进入官网该产品页面

版权© ICY DOCK 中国，保留所有权利。650323 VER 1.0

1 包装内容



设备



说明书

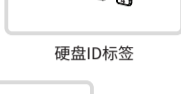

硬盘ID标签

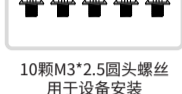

10颗M3*2.5圆头螺丝
用于设备安装
(2颗备用螺丝)

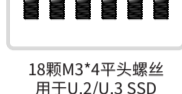

18颗M3*4平头螺丝
用于U.2/U.3 SSD
(2颗备用螺丝)

① 注意：请使用随附的螺丝固定设备和硬盘。

2 设备信息

▼ 前视图

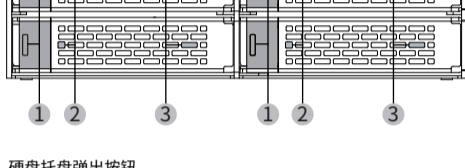

- ① 硬盘托盘弹出按钮
- ② LED指示灯 (硬盘通电：绿灯恒亮，硬盘读取：绿灯闪烁)
- ③ 硬盘ID标签插槽

▼ 后视图

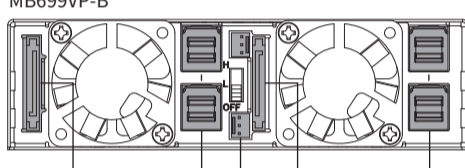

MB699VP-B

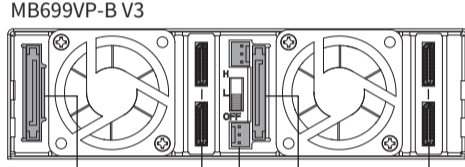

MB699VP-B V3

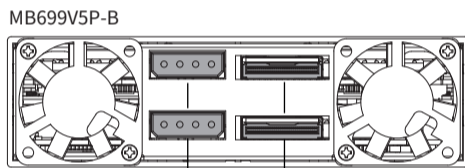

MB699V5P-B

- ① 15 Pin 电源接口
- ② 3 Pin 风扇接口
- ③ Mini-SAS HD 接口
- ④ OcuLink 接口
- ⑤ Molex 4-pin 电源接口
- ⑥ MCIO 8i 接口(SFF-TA-1016)

3 硬盘安装步骤

3-1

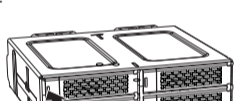

3-2



3-3



3-4



托盘可容纳高度不超过 15 毫米的 U.2/U.3 固态硬盘。将托盘和硬盘翻转至底部朝上，即可插入硬盘。

3-5

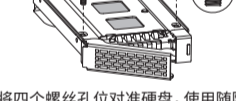

4颗 M3*4 螺丝

将四个螺丝孔位对准硬盘，使用随附的 M3*4 螺丝进行安装。

3-6



将装好硬盘的托盘重新插入设备，即可完成安装。

(可选)

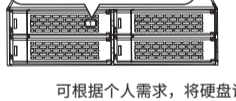

硬盘ID标签

①

可根据个人需求，将硬盘识别标签的插头插入对应插槽。

4 设备安装步骤

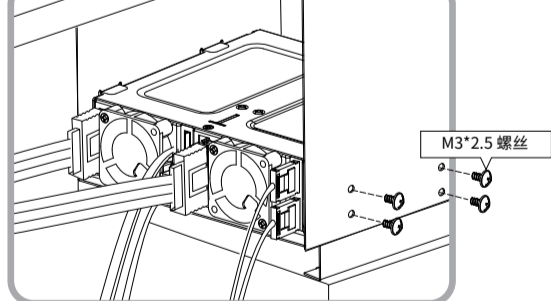

1. 将设备插入标准 5.25 英寸光驱位，并使用随附的 M3*2.5 螺丝固定设备。
2. 将数据线和电源线连接至设备，即可完成安装。

